

2T0027TR | CTEVO DOWNLIGHT 38

LED recessed downlight with high low optics for high performances. Trimless version

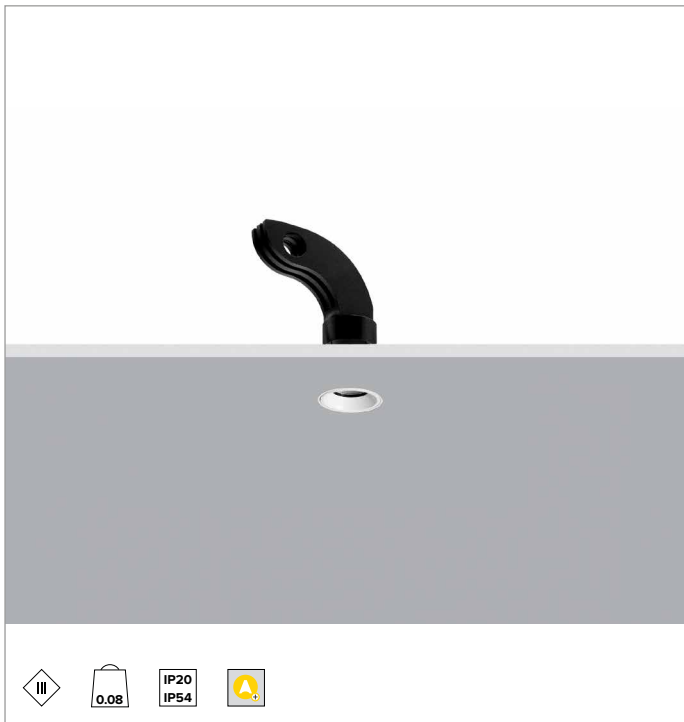

		4000K	H(m)	D(m)	Emax(lx)
		Ra90			53°
Fixture Power	6W	1	0.99	621	
Source Flux	721lm	2	1.97	155	
Fixture Flux	515lm	3	2.96	69	
Efficacy	82lm/W	4	3.95	39	
TS1713	Imax=862cd/klm	Imax	621cd	5	4.94

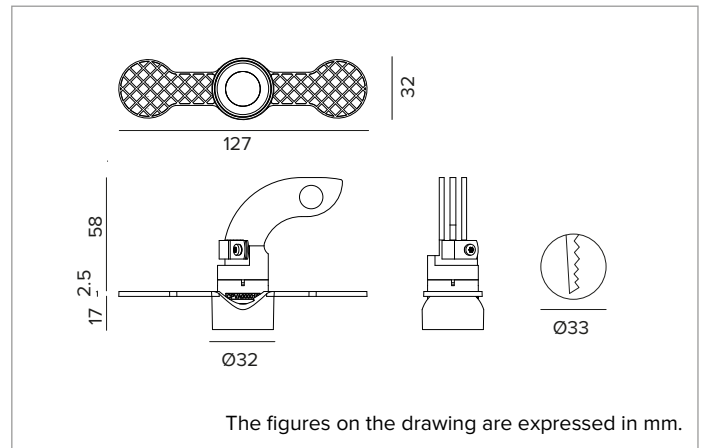

SOURCE

High efficiency Chip on Board LED Ra90.

Energy efficiency class: F

Nominal power: 6,3W

Nominal flux: 721lm

Colour rendering index: 90

Rf: 90

Rg: 98

CCT nominal: 4000K

Lifetime (L80/B10): >50000h tq +25°C

ILLUMINOTECHNICAL CHARACTERISTICS

Classic version with WFL low optics: front in white painted thermoplastic material, metallised thermoplastic material reflector, holographic acrylic diffuser screen. UGR<19 and L65<1000 cd/m² (EN 12464-1). IP54 protection for the visible parts of the installed fixture.

Optic: REFLECTOR

Beam angles: WFL

Optical efficiency: 71%

Fixture flux: 515lm

Luminous efficacy: 82lm/W

Photobiological safety: Compliant with RG1 low risk group

MECHANICAL CHARACTERISTICS

Heat sink in black aluminum obtained by CNC machining process, structure in thermoplastic material and silicone gasket for sealing against water and dust. Trimless version with a load-bearing element for installation and finishing in plasterboard.

Colour and finish: Plaster white

Weight: 0.08Kg

Version: TRIMLESS

Degree of protection: IP20 for recessed part

Degree of protection: IP54 for exposed part

ELECTRICAL CHARACTERISTICS

To be completed with electronic ON-OFF or DALI driver for wiring of a single product or for wiring in series up to a maximum of 4 products.

Fixture Power: 6W

Power supply: 500mA

Insulation Class: CLASS 3

Driver included: NO

Class F: YES

Ambient temperature: 0°C / +25°C

INSTALLATION

Quick tool-free mounting system for false ceiling installation from 13 to 17mm (TRIMLESS).

NOTES

Casambi control system available via accessory (only for products with DALI driver). 110-277Vac version available on request. Commissioning of the control system via free APP; the intervention of a specialist technician can be quoted on request.

WARRANTY

5 years.

WARNING

Luminaire designed for disposal/recycling at end-of-life. Replaceable (LED only) light source by a professional.

Due to the technological evolution of the electronic components, the data provided may be updated, and as such, confirmation must be requested during the order process.

Luminous flux and power supply have +/-10% tolerances with respect to the indicated value. tq +25°C (CIE 121).

We reserve the right to make technical changes.

Targetti Sankey S.r.l.
Via Pratese, 164
50145 Firenze - Italy
Tel: +39 055 37911
targetti.com
targetti@targetti.com

CCIAA Firenze
Share Capital:
€ 500.000,00
VAT N. (IT):
01537660480
R.E.A: FI-275656

TARGETTI

2T0027TR | CTEVO DOWNLIGHT 38

LED recessed downlight with high low optics for high performances. Trimless version

Related codes

Power Supply

Dimensions LxHxP mm	Power	Power supply	Output current	IP	Code	Dimensions LxHxP mm	Power	Power supply	Output current	IP	Code
158x19x22	max 14W	110-240Vac	500mA	IP20	1T9638EL	124x21x31	max 10W	220-240Vac	500mA	IP20	1T9638DA
124x22x79	max 50W	110-240Vac	500mA	IP20	1T9639EL	124x22x79	max 27W	110-240Vac	500mA	IP20	1T9639DA

Electronic ON-OFF power supply.

DALI power supply.

Accessories

Emergency Kit



Code

A059

Emergency kit composed of an inverter a LiFePO4 battery and a LED Green indicator. Allows permanent EP emergency use of the fixture it is connected to. The 1h or 3h autonomy can be selected by configuring the fixture. The batteries take 12h to completely recharge. LED Green indicator wired to the inverter through single-core cables L= 800mm. Emergency kit for fixtures that comply with EN 60598-2-22 standard, high risk areas excluded. Battery size 160x54x30 mm. Inverter size 165x40x25 mm.

Control systems



Code

1T5349

IP20 wireless control unit with DALI interface. It generates a local DALI2 bus, enabling a direct connection to a DALI interface LED driver. The module can only be used in a closed system and cannot be connected to an existing DALI network. The module is wireless controlled using a Casambi app for smartphones and tablets using Bluetooth 5.0 technology. The devices automatically create an adaptive, robust, and reliable wireless mesh network, allowing for the easy and efficient management of a high number of fixtures. The control unit is preset to the DALI 1CH profile, meaning the device can control a single DALI driver with broadcast commands. In addition to the DALI broadcast, other operating modes are available, such as:

- Button (normally open)
- Control unit 0/1-10V
- Control unit DALI Tunable White DT8
- Presence sensor



Code

2T0131

IP20 Extender for wireless control of LED driver with dimming DALI (or 1-10V) interface based on Casambi technology. It has a DALI2 output with the capacity to control up to 40 lighting fixtures. With the addition of a further external BUS DALI power supply it is possible to control up to 64 fixtures. IP20 Extender is preset to the DALI broadcast profile, meaning all the luminaires connected to it are dimmable at the same level. In addition to the DALI broadcast other operating modes are available, such as:

- EXTENDER DALI 8CH
- EXTENDER DALI Tunable White
- EXTENDER 0/1-10V
- EXTENDER DALI 4CH
- EXTENDER DALI DT8 Tunable White

Due to the technological evolution of the electronic components, the data provided may be updated, and as such, confirmation must be requested during the order process.

Luminous flux and power supply have +/-10% tolerances with respect to the indicated value. tq +25°C (CIE 121).

We reserve the right to make technical changes.

Targetti Sankey S.r.l.
Via Pratese, 164
50145 Firenze - Italy
Tel: +39 055 37911
targetti.com
targetti@targetti.com

CCIAA Firenze
Share Capital:
€ 500.000,00
VAT N. (IT):
01537660480
R.E.A.: FI-275656

TARGETTI